

# **Audionet**

## **ART G3**

Aligned Resonance Transport  
Compact Disc Player

### **User's Manual**



# Contents

<b>1</b>	<b>Preface</b> .....	<b>5</b>
1.1	Included.....	6
1.2	Transport.....	6
<b>2</b>	<b>Overview front panel</b> .....	<b>7</b>
<b>3</b>	<b>Overview back panel</b> .....	<b>8</b>
<b>4</b>	<b>Installation and power supply</b> .....	<b>9</b>
4.1	Placement .....	9
4.2	Mains connection .....	9
4.3	Orientation of mains plug .....	10
4.4	Connecting the external power supply EPS or EPX.....	10
<b>5</b>	<b>Outputs and inputs</b> .....	<b>12</b>
5.1	Outputs 'Analog Audio' .....	12
5.2	Output/Inputs 'Digital Audio' .....	13
5.3	Digital output formats.....	14
5.3.1	LowBit mode .....	14
5.3.2	HighBit mode .....	15
5.4	USB/SPDIF digital audio input .....	16
5.4.1	Connecting the computer to the USB audio input.....	16
5.4.2	Using the SPDIF inputs .....	20
5.5	Audionet Link.....	21
<b>6</b>	<b>Usage</b> .....	<b>23</b>
6.1	Switching on and off.....	23
6.1.1	Mains phase detection .....	24
6.1.2	Using Audionet Link .....	24
6.2	Inserting and removing discs.....	25
6.3	Control elements on the front panel .....	26
<b>7</b>	<b>Audionet Metal Remote Control</b> .....	<b>27</b>
7.1	Key Assignment RC 1 .....	28
7.2	Changing the batteries .....	30
7.3	Settings for Audionet preamplifier .....	30

<b>8</b>	<b>Playing discs .....</b>	<b>32</b>
8.1	Playable disc types.....	32
8.2	Basic playback control .....	34
8.3	Searching.....	35
<b>9</b>	<b>Playback Options menu.....</b>	<b>36</b>
9.1	Time Display .....	37
9.2	Repeat Playback .....	38
9.2.1	Repeat disc .....	38
9.2.2	Repeat track.....	39
9.3	Random playback.....	39
9.4	Time search.....	40
9.5	Program Playback.....	41
9.5.1	Edit a playlist.....	42
9.5.2	Playing a playlist .....	44
9.5.3	Delete a playlist .....	45
<b>10</b>	<b>Setup menu Global Setup.....</b>	<b>46</b>
10.1	Set SPDIF Digital Input .....	47
10.2	Set Digital Output Mode.....	48
10.3	Set Display Brightness.....	49
10.4	Set AutoOff .....	50
10.5	Set AutoPlay.....	50
10.6	Overview factory defaults.....	51
<b>11</b>	<b>Security advice .....</b>	<b>52</b>
<b>12</b>	<b>Technical data .....</b>	<b>53</b>

# 1 Preface

The Audionet Team congratulates you on your purchase of this unit.

The predecessor model ART G2 is considered to be one of the best-sounding CD players ever made, boasting unique acoustic and design characteristics that convinced music-lovers around the world. An impressive list of test victories, distinctions, and awards testifies to the long and triumphant reign of the ART G2.

Curtain call for the third generation of CD player: the new ART G3 (**Generation 3**) is nothing less than Audionet's final statement for reproducing the classical compact disc. At the same time, it also represents a thoroughbred high-end D/A converter. Its sound quality can be used via further digital systems, especially computers. This is possible via optical and electrical digital inputs.

The ART G3 is geared towards the requirements of classical stereophony. Expert connoisseurs of high-quality musical reproduction will find the product not only delivers the aural satisfaction they dream of, but even opens up previously unknown musical realms. Combining craft with precision and presence, ART G3 fulfils its makers' vision of pushing back the quality frontiers of classical CD playback to rival the standard of advanced high-resolution media. ART G3 is equipped with the potential to become a further milestone in audiophile acoustic art.

But before you start listening to your new Audionet ART G3, please read this manual carefully so you are able to use and enjoy all functions of this unit without drawback on music quality.

## 1.1 **Included**

Included you will find the following items:

- the Compact Disc player Audionet ART G3
- the Audionet Metal Remote Control *RC 1*
- the user's manual (that you are currently reading)
- one low resonance stabilizer made of black POM
- one standard mains cord
- one optical Toslink cable (Audionet Link)

## 1.2 **Transport**



### **Important**

- Please transport the ART G3 only in the included package.
- **Never** leave a CD or the stabilizer inside the ART G3 during transport. The sensitive mechanics of the drive could suffer damage.
- Always use the included bag to prevent scratches on the housing.
- Please allow the ART G3 to adapt to the climatic conditions in your listening room after transport. As known for every optical device, low temperatures and humidity may cause the laser unit to be covered with condensation. Leave the drawer of the ART G3 open for several hours before switching on the first time after transport.

## 2 Overview front panel

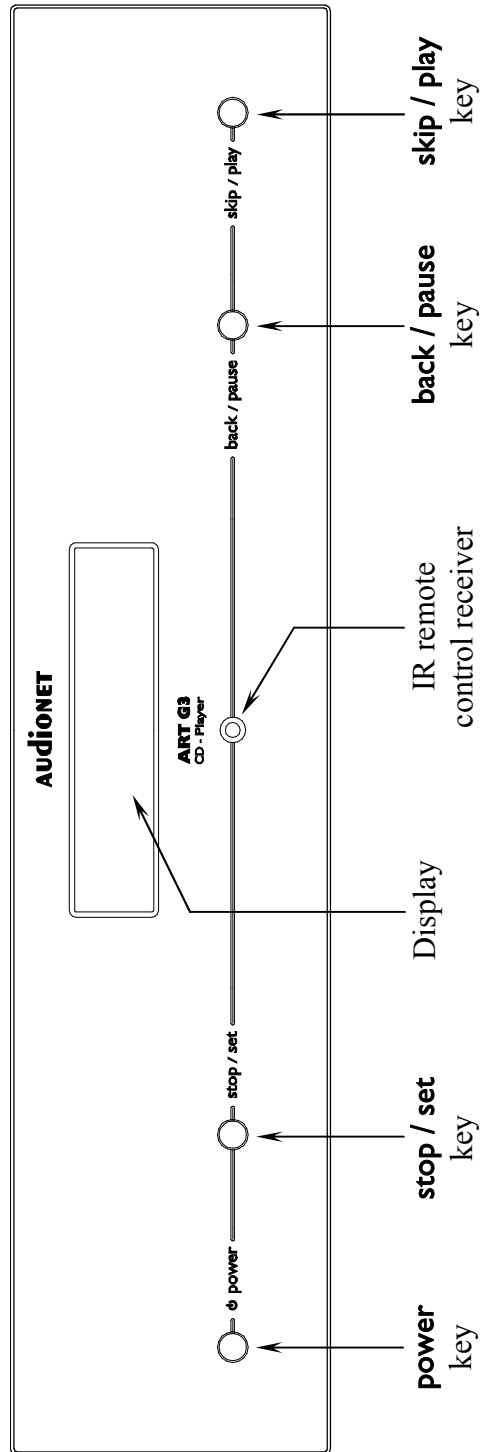

### 3 Overview back panel

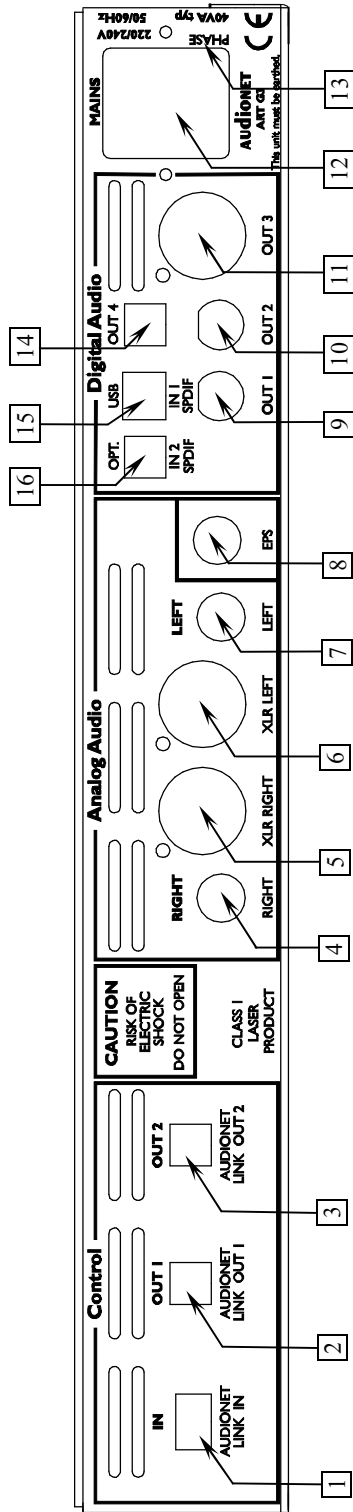

- |   |  |    |                                    |
|---|--|----|------------------------------------|
| 1 | Audionet Link input                          | 9  | Digital output 1 (RCA)             |
| 2 | Audionet Link output 1                       | 10 | Digital output 2 (RCA)             |
| 3 | Audionet Link output 2                       | 11 | Digital output 3 (AES/EBU)         |
| 4 | Analog output Right (RCA)                    | 12 | Mains input                        |
| 5 | Analog output Right (balanced)               | 13 | Marking mains phase                |
| 6 | Analog output Left (balanced)                | 14 | Digital output 4 (optical)         |
| 7 | Analog output Left (RCA)                     | 15 | Digital input IN 1 (USB/SPDIF)     |
| 8 | Input for external power supply Audionet EPS | 16 | Digital input IN 2 (SPDIF optical) |



## 4 Installation and power supply



### Important

- During connecting or removing the ART G3 to/from a preamplifier both units and the corresponding power amplifiers have to be switched off to prevent damage of the ART G3 or any of the other connected units.
- Please make sure that all cables are in absolute best conditions! Broken shields or short-cut cables could damage the ART G3 and/or any other connected unit.

### 4.1 Placement



### Important

- It is recommended to place the ART G3 into a high quality rack or onto a stable table.
- Do not expose the unit to direct sunlight.
- Do not place the ART G3 in close range to heat sources like radiators.
- Do not place the ART G3 on top of other units, especially not on top of power amplifiers, preamplifiers or similar that produce heat. Both units could suffer damage from thermal overload.
- Do not use the unit in a place where it is exposed to vibrations.
- Do not place the unit close to loudspeakers or into the corner of a room where it is exposed to high levels of sonic energy, which might reduce the sound quality of the unit.

### 4.2 Mains connection

The mains input 12<sup>\*</sup> is on the back panel of the ART G3. To connect the unit to mains use the included mains cord. If you prefer to use a different power cord make sure that it meets the specifications for your home country.

---

<sup>\*</sup> see numbers in section 'Overview back panel' on page 8.



### Important

- **The electrical specifications of your home country must meet the electrical specifications printed onto the back panel.**
- The ART G3 is a Class I unit and must be earthed. Please ensure a stable earth connection. 'Phase' ('hot' pin) is marked on the back panel ('PHASE') [13].
- Never pull the mains plug while the ART G3 is switched on! Always power down the unit to stand-by mode first, before you pull the mains cord from the mains input [12] on the back panel of the unit. Wait at least 3 minutes before you re-plug the unit to mains.

Only in case of extended absence (like vacations) or if massive trouble on the mains power is to be expected you should disconnect the unit from mains. To disconnect the ART G3 completely from mains pull the mains plug.

### 4.3 Orientation of mains plug

The correct polarization of mains is important for reasons of audio clarity and stability. Please connect the mains cord that the hot pin of the wall outlet is connected to the pin of mains input [12] marked 'PHASE' [13] on the back panel of the unit. Your Audionet ART G3 is able to detect a wrong polarization of the mains plug during start-up. If the message

►           **Attention:**           ◄  
► **Mains Phase incorrect** ◄

appears in the display, switch off the unit and flip the mains plug in the wall outlet (refer to section '*Mains phase detection*' on page 24).

### 4.4 Connecting the external power supply EPS or EPX

To use one of the optional external power supplies EPS or EPX with your ART G3 follow these steps:

1. **Make sure both ART G3 and EPS / EPX are switched off and disconnected from the mains.**
2. **Connect the EPS / EPX with the included cable to input jack [8] on the back panel of the ART G3. The shape of the plug prevents any wrong polarity. The small 'nose' inside the plug has to face upwards. Now screw the ring of the plug onto the input jack [8].**

3. Connect **both** (!!) units (ART G3 **and** EPS / EPX) to mains.
4. Switch on the EPS / EPX at the back panel first.
5. Use key power at the front panel or the key ART of the Audionet Metal Remote Control *RC 1* to switch on the ART G3. The ART G3 is now ready to use and gets its power from the external power supply EPS / EPX.
6. To switch off the ART G3 into stand-by mode, use the key power on the front panel or key ART of the Audionet Metal Remote Control *RC 1*.



#### **Important**

- Never switch on or off the EPS / EPX on its back panel while the ART G3 is switched on or during playback.
- For further information referring to the external power supply EPS / EPX please consult its user's manual.



#### **Tip**

- Use a high quality cable (for example the Audionet P10) to connect the EPS / EPX to mains. The sound will improve.

## 5 Outputs and inputs



### Important

- During connecting or removing the ART G3 to/from a preamplifier both units and the corresponding power amplifiers have to be switched off to prevent damage of the ART G3 or any of the other connected units.
- Please make sure that all cables are in absolute best conditions! Broken shields or short-cut cables could damage the ART G3 and/or any other connected units.

### 5.1 Outputs 'Analog Audio'

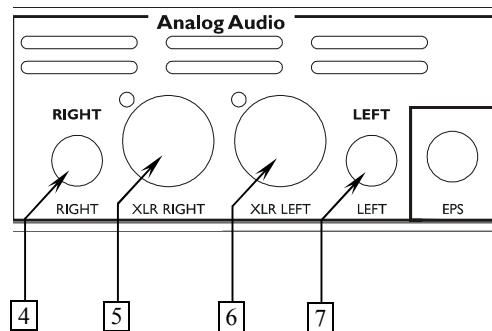

- 4 RIGHT**  
analog audio output of right channel (RCA)
- 5 XLR RIGHT**  
analog audio output of right channel (balanced / XLR)
- 6 XLR LEFT**  
analog audio output of left channel (balanced / XLR)
- 7 LEFT**  
analog audio output of left channel (RCA)

Connect the analog outputs **4** and **7** of your ART G3 to your (pre) amplifier using high quality interconnectors. Alternatively, you can use the balanced analog outputs **5** and **6** in case your (pre) amplifier has no analog RCA inputs.

## 5.2 Output/Inputs 'Digital Audio'

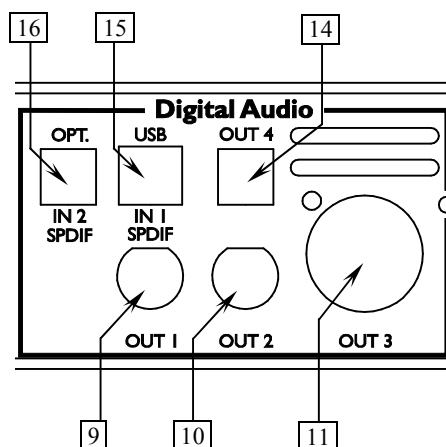

### 9 Digital output OUT 1 (SPDIF)

The digital audio signal is available at the output **OUT 1** in the SPDIF format depending on the setting of option **Set Digital Output Mode** (refer to sections '*Digital output format*' on page 14 and '*Set Digital Output Mode*' on page 48).

### 10 Digital output OUT 2 (SPDIF)

The digital audio signal is available at the output **OUT 2** in the SPDIF format depending on the setting of option **Set Digital Output Mode** (refer to sections '*Digital output format*' on page 14 and '*Set Digital Output Mode*' on page 48).

### 11 Digital output OUT 3 (AES/EBU)

The digital audio signal is available at the output **OUT 3** in the AES/EBU format depending on the setting of option **Set Digital Output Mode** (refer to sections '*Digital output format*' on page 14 and '*Set Digital Output Mode*' on page 48).

### 14 Digital output OUT 4 (optical/TOSLink)

Use an optical (TOSLink) cable to connect the optical digital output **OUT 4** of the ART G3 to any unit with an optical digital input. The output signal depends on the setting of option **Set Digital Output Mode** (refer to sections '*Digital output format*' on page 14 and '*Set Digital Output Mode*' on page 48).

### 15 Digital input IN 1 (USB/SPDIF)

Digital audio input to connect a computer to the ART G3 for playback of music and sound files using the sophisticated D/A-converter of the ART G3. The ART G3 is recognized as 'USB Audio Device' by the operating system of your computer, e.g. Windows 7<sup>\*1</sup>. Use a standard audio player (e.g. Windows Media Player<sup>\*1</sup>) to playback your music through the ART G3.

Via an optional adapter cable the USB input can be used as SPDIF

---

<sup>\*1</sup> 'Microsoft Windows' and 'Windows Media Player' are registered trademarks of Microsoft Corporation and were only used for information purposes.

input for connecting CD players, DAT recorders etc. (refer to section 'USB/SPDIF digital audio input' on page 16).

## 16 Digital input IN 2 (optical/TOSLink)

Audio input to connect digital devices (CD-Players, DAT recorders etc) via optical fibre cable. This input is also available for the usage of the D/A-converter.

## 5.3 Digital output formats



### Important

- In order to use digital outputs **OUT 1** to **4** of your ART G3, the option **Set Digital Output Mode** has to be set to either **LowBit Mode** or **HighBit Mode**. If you selected setting **disabled** all digital outputs of the ART G3 are **switched off** (refer to section 'Set Digital Output Mode' on page 48).

Please refer to the following table to determine which digital format at which sample rate and resolution is available at the digital audio outputs. The decision whether to use the HighBit or the LowBit mode depends on the kind of digital receiver unit your ART G3 is connected to.

Digital Output Mode	OUT 1 <sup>9</sup> SPDIF	OUT 2 <sup>10</sup> SPDIF	OUT 3 <sup>11</sup> AES/EBU	OUT 4 <sup>14</sup> optical
<b>LowBit Mode</b>	44.1kHz / 16bit Stereo PCM	44.1kHz / 16bit Stereo PCM	44.1kHz / 16bit Stereo PCM	44.1kHz / 16bit Stereo PCM
<b>HighBit Mode</b>	192kHz / 24bit Stereo Upsampling Audionet High Bit Mode		96kHz / 24bit Stereo Downsampling PCM	44.1kHz / 16bit Stereo PCM
<b>disabled</b>	no signal	no signal	no signal	no signal

### 5.3.1 LowBit mode

Use the LowBit mode to connect the ART G3 with a component (digital receiver) that has **no** Audionet HighBit-Interface. Referring to the table below all digital outputs **OUT 1** <sup>9</sup> to **OUT 4** <sup>14</sup> transmit a stereo PCM signal at a sampling rate of 44.1 kHz and with a resolution of 16 bit.

### 5.3.2 HighBit mode

Use the HighBit mode **only** if you want to transmit digital audio data from the ART G3 to an Audionet preamplifier compatible to the Audionet HighBit-Interface, e.g. the Audionet DNx (except DNA 1) or Audionet MAP 1. Additionally, in the HighBit mode digital output **OUT 3** 11 transmits a stereo PCM signal at a sampling rate of 96 kHz (downsampled from the Audionet HighBit 192 kHz signal) with a resolution of 24 bit in the AES/EBU format. Digital output **OUT 4** 14 transmits even in the HighBit mode a stereo PCM signal at a sampling rate of 44.1 kHz and a resolution of 16 bit.



#### Important

- With other devices but HighBit-compatible Audionet preamplifiers a correct decoding of digital audio data is **not** possible and can lead to high-level noise from the speakers, which might damage your ear and/or equipment.

In order to transmit digital audio data from your ART G3 to an Audionet preamplifier, you have to connect digital output **OUT 1** 9 of the ART G3 to the digital audio input '**Digital In 2**' of the MAP V2 or '**Digital Audio IN 1**' of the MAP 1 or DNx (except DNA 1).

Additionally, connect digital output **OUT 2** 10 of the ART G3 to digital audio input '**Digital In 3**' of the MAP V2 or '**Digital Audio IN 2**' of the MAP 1 or DNx (except DNA 1).



#### Important

- Only if **both** connections are in place and the option **Set Digital Output Mode** is set to **HighBit Mode**, you can transmit and receive digital audio data in HighBit mode (refer to section '*Set Digital Output Mode*' on page 48)!



#### Important

- If you do not need any of the digital outputs do not use any jumpers to short-circuit the digital outputs. Instead, select **disabled** for option **Set Digital Output Mode** to switch off all digital outputs. (refer to section '*Set Digital Output Mode*' on page 48).

## 5.4 USB/SPDIF digital audio input

### 5.4.1 Connecting the computer to the USB audio input

With the USB Audio interface you can playback music and sound files from your computer (PC) using the sophisticated digital-to-analog converters of the ART G3 instead of the soundcard of the PC. The ART G3 is integrated into your computer system as USB Audio device. The installation is done (mostly) automatically via Plug'n'Play, provided a correctly installed operating system.



#### Note

- To use the USB Audio function of the ART G3, your computer requires having Microsoft™ Windows™ XP™ or newer, Apple OS X 10.1 or higher or a current Linux version as operating system, with the latest USB Audio drivers installed. For further information about the minimum system requirements please refer to the documentation of your installed operating system.
1. **Connect digital input IN I 15 with a suitable USB cable (plug type A to plug type B) to a free USB port at your computer that is compatible with USB 1.1 or above and supports the Full Speed USB protocol.**
  2. **Start your computer, then switch on the ART G3.**

The ART G3 is recognized as newly added hardware by your computer. Depending on the operating system installed on your computer, it might occur that at the first connection of the ART G3, the operating system prompts you to install a driver for the new hardware.

- If necessary, Windows may prompt you to insert its installation CD/DVD. Please have the disc ready.
- For further information about automatic hardware recognition, searching for and installing hardware drivers, please refer to the documentation of your operating system.
- USB Audio is an integral part of up to date operating systems, so no further software installation is necessary. After installing the necessary hardware drivers the ART G3 will be automatically integrated into your computer system from now on and is ready to use after plugging in the USB cable.

Depending on the installed operating system the ART G3 will be automatically setup as standard device for sound playback. In case this is not done automatically due to your current system configuration, please set the corresponding option manually:



### 3. Selecting the audio output device

#### a) Microsoft™ Windows™

Open up the 'Sounds and Audio Devices' dialog of your Windows Settings menu. Click on the tab 'Audio' and select 'Audionet ART G3' from the list of standard devices (see the following example):



#### b) Mac OS X

Open the 'System Preferences' and select the preference pane 'Sound'. Click on the tab 'Output', and select 'Audionet ART G3' as output device.

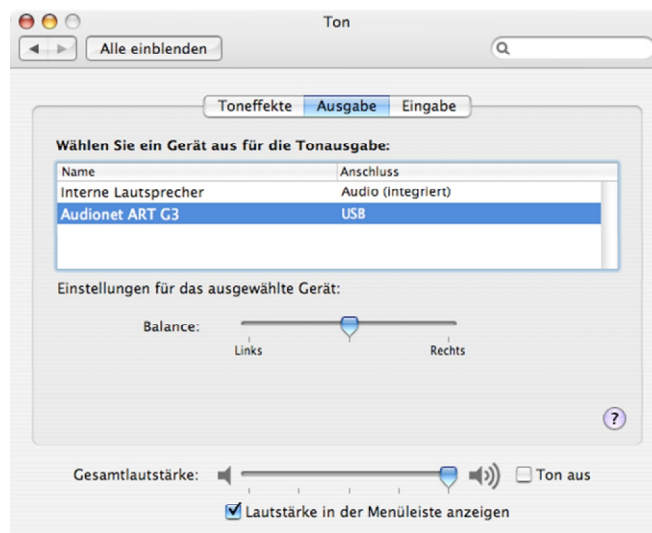

## c) Linux

Open the 'System Settings' and select 'Sound & Multimedia'. Now open the item 'Music' in the 'Audio Output' dialog, and select 'IDEKTRON GmbH & Co. KG. Germany Audionet ART G3 (USB Audio)' as 'Output Device Preference for the Music Category'.

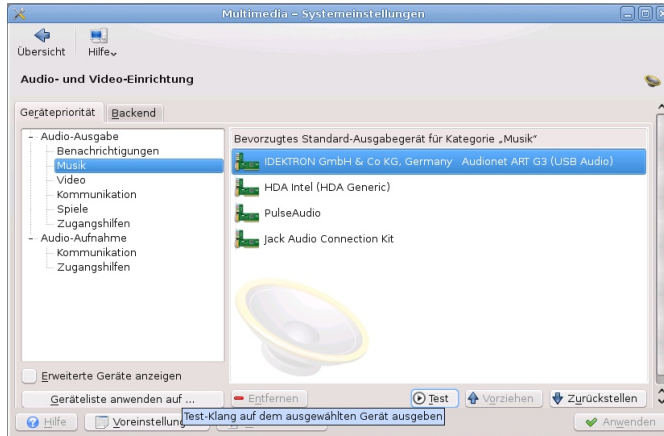

Now all music and sound files, that you playback on your computer are played back using the sophisticated analog-to-digital converters of your ART G3.



### Note

- All volume and balance settings of your operating system or your sound application will be still active. In case you hear no sound at all or the sound has low volume while playing back sound and music files with your ART G3, please make sure that your volume settings of your operating system or sound application are not muted or set to a low level.



### Important

- The USB Audio function of the ART G3 can **only** be used if the loaded disc is stopped, or **no** disc is loaded at all.
- During playback of any disc with the ART G3 you will hear **only** the audio from the disc. There will be **no** signal from the USB Audio interface.
- Option **Set Auto Off** in the Global Setup menu has to be set to **never off**, if you would like to use the USB Audio function of the ART G3, otherwise the unit will shut down automatically after 30 minutes (refer to section '*Set AutoOff*' on page 50).



## Notes on Microsoft™ Windows™

- Microsoft Windows will setup the ART G3 automatically as standard device for sound playback. In case this is not done automatically due to your current system configuration, please set the corresponding option manually.
- Microsoft Windows converts every input format automatically into a stereo PCM signal with 44.1 or 48 kHz sampling frequency and 16 bits resolution. Which audio formats are played back depends on the capabilities of your Microsoft Windows system and/or your sound application only!

In case you like to check, if Microsoft Windows recognized your ART G3 correctly, please open up the Device Manager of your Windows system. You will find the ART G3 in the following 3 places in the list of devices:

1. Sound, video and game controller → USB Audio Device
2. Human Interface Devices → USB Human Interface Device
3. Universal Serial Bus controllers → USB Composite Device

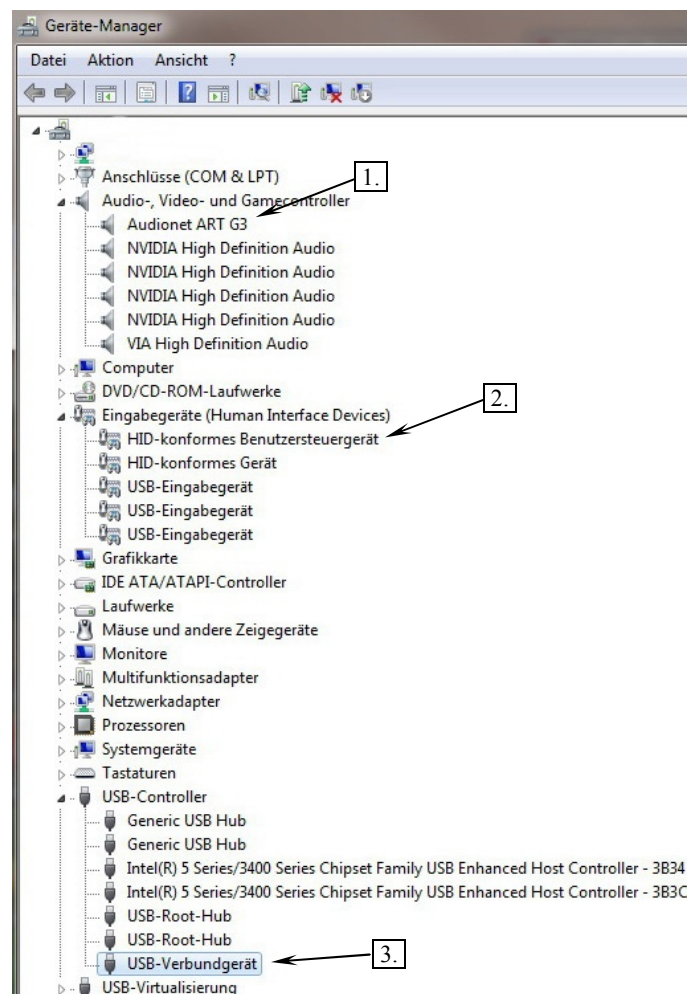

## 5.4.2 Using the SPDIF inputs

You can use **Digital Audio IN 2** [16] or the **USB/SPDIF Digital Audio Input IN 1** [15] (with a special adapter cable, pin layout see below) as SPDIF digital audio input. Therefore, you can use the sophisticated digital-to-analog converter of the ART G3 for other digital sources like CD transports, DAT recorder, too.

1. Connect the **USB/SPDIF Audio input** [15] to the SPDIF output of the source device using an adapter cable. Alternatively you can use an optical fibre cable to connect the source device to the **Digital Input IN 2** [16].
2. Switch on the ART G3, and select in the main menu the digital input of your choice (refer to section '*Set SPDIF Digital Input*' on page 47).
3. Switch on the source device, and start the playback on the source device.

The music of the source device is now played back using the sophisticated digital-to-analog converters of the ART G3.



### Note

- The ART G3 supports the following formats: PCM Stereo, sample rate 32 kHz up to 96kHz, 16 bit and 24 bit resolution.



### Important

- The SPDIF Audio function of the ART G3 can **only** be used if the loaded disc is stopped, or **no** disc is loaded at all.
- During playback of any disc with the ART G3 you will hear **only** the audio from the disc. There will be **no** signal from the SPDIF Audio interface.
- Option **Set Auto Off** in the Global Setup menu has to be set to **never off**, if you would like to use the SPDIF Audio function of the ART G3, otherwise the unit will shut down automatically after 30 minutes (refer to section '*Set AutoOff*' on page 50).



### Note:

#### Pin layout of SPDIF input



- 1 = not connected
- 2 = not connected
- 3 = SPDIF
- 4 = Ground

## 5.5 Audionet Link

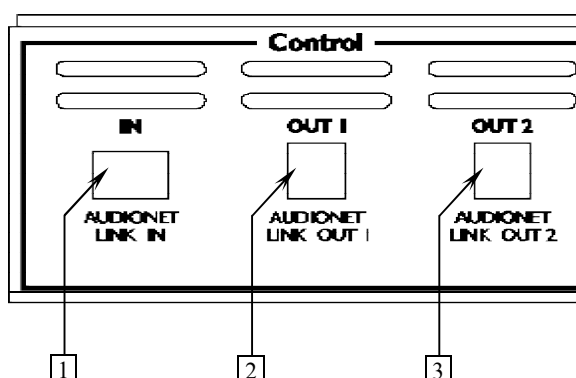

- 1 Control input IN**  
Audionet Link control input
- 2 Control output OUT 1**  
Audionet Link control output 1
- 3 Control output OUT 2**  
Audionet Link control output 2 (time-delayed in reference to control output **OUT 1**)

For your convenience, the ART G3 can be controlled remotely by one of Audionet's pre- or integrated amplifiers using the 'Audionet Link' interface.

You only need a simple optical Toslink cable to connect the Audionet Link output of your Audionet preamplifier to the Audionet Link input **1** of the ART G3. Now, the ART G3 and all other units connected via Audionet Link will be switched on/off automatically, when you switch on/off your preamplifier at the front panel or by remote control.

In case you would like to automatically control further Audionet units in your system with the Audionet Link interface, please connect the Audionet Link output **OUT 1** **2** or **OUT 2** **3** of the ART G3 to the Audionet Link input of the next Audionet unit (e.g. power amplifier) using a simple optical Toslink cable.



### Note

- The 'switch on' signal is issued to any further Audionet units daisy chained to the Audionet Link output of your ART G3 with a little delay to avoid all units switching on at the same moment, which could cause an overload of your mains fuse. First, control output **OUT 1** **2**, then **OUT 2** **3** is switched on.
- Independently from the Audionet Link interface, you can switch on/off your ART G3 manually at any time by using the **power** key on the front plate or the remote control.

- If you switch off your Audionet chain using Audionet Link, it is important to wait until **all** devices are shut down before you restart the system.



### **Important**

- In case the option **Set AutoOff** is set to **shut off in 30 min**, the ART G3 shuts down to stand-by mode automatically, if the disc is stopped or no disc inserted and no key of the front panel or remote control is used for at least 30 minutes. This function works independently from a preamplifier that is connected via Audionet Link, i.e. the ART G3 shuts down automatically even if the preamplifier is still switched on (refer to section '*Set AutoOff*' on page 50).

## 6 Usage

### 6.1 Switching on and off

Please make sure that the ART G3 is connected to your (pre-) amplifier and to the mains correctly (refer to sections '*Installation and power supply*' on page 9 and '*Outputs and inputs*' on page 12). As soon as the ART G3 is connected to the mains, the display lights up with the Audionet logo followed by a welcome text. After that the display stays dark. The unit is now in stand-by mode.

Switch on the unit by pressing the **power** key at the front panel. The ART G3 shows the message **Waking up...**

In case the mains plug has the incorrect polarization a warning is issued in the display (refer to section '*Orientation of mains plug*' on page 10).

If the cover is open the display reads **Open**. If you switch on the unit with the cover closed and no disc inserted the message **No Disc** will appear in the display after a short moment.

Please refer to sections '*Inserting and removing discs*' on page 25 and '*Playing discs*' on page 32 for how to insert, remove and play discs.

If you would like to switch off the unit, press the **power** key on the front panel. The display will show **Going to sleep..** while powering down the unit. Now the display is dark, and the ART G3 is in stand-by mode.



#### Note

- In case option **Set AutoPlay** is set to **power on only** or **power on & disc change** (refer to section '*Set AutoPlay*' on page 50) the ART G3 switches on automatically after connecting it to mains and starts playing any inserted CD.
- Of course, you can switch on/off the ART G3 with the Audionet Metal Remote Control *RC 1*. Please refer to section '*Audionet Metal Remote Control*' on page 27.
- In case you should try to switch on the unit while the cover is open, the ART G3 will issue the message:

```
▶      Attention:      ◀  
▶      Close cover before ◀  
▶      switching on!!  ◀
```

to ask you to close the cover. Only if the cover is closed you can switch on the unit!

- If you open the cover during power-up, the ART G3 interrupts the process with the warning:

```
▶      Attention:      ◀  
▶      Keep cover closed ◀  
▶      during power up!! ◀
```

Now close the cover, and switch on the unit again!

### 6.1.1 Mains phase detection

The correct polarization of mains is important for reasons of audio clarity and stability. Please align the mains cord so that the hot pin of the wall outlet is connected to the pin of mains input 12 marked 'PHASE' 13 on the back panel of the unit. The ART G3 recognizes the incorrect polarization of the mains plug automatically. Right after switching on the unit from stand-by mode by pressing the **power** key on the front panel the following message will appear in the display in case the mains polarization is incorrect:

▶           **Attention:**           ◀  
▶   **Mains phase incorrect**   ◀

If you read the above message, switch off the unit by pressing the **power** key. Please wait until the display no longer reads **Going to sleep...** Now pull the mains plug and re-insert it into the mains socket rotated by 180°.

When you switch on the unit again, the warning should not appear now.



#### Important

- If the ART G3 issues the mains polarization warning or no warning at all for both positions of the mains plug, check the connection to earth of your mains socket and mains cord. **You have to ensure a stable connection to earth for the ART G3 to work correctly!**

### 6.1.2 Using Audionet Link

For your convenience, the ART G3 can be controlled remotely by one of Audionet's pre- or integrated amplifiers using the Audionet Link interface.

You only need a simple optical Toslink cable to connect the Audionet Link output of your Audionet preamplifier to the Audionet Link input 1 of the ART G3. Now, the ART G3 and all other units connected via Audionet Link will be switched on/off automatically, when you switch on/off your preamplifier at the front panel or by remote control (refer to section '*Audionet Link*' on page 21).

If your ART G3 is connected to your Audionet preamplifier via Audionet Link, the ART G3 will be switched on/off automatically, as soon as you switch on/off your Audionet preamplifier with its remote control or with the **power** key on its front panel.



#### Note

- The 'switch on' signal is issued to any further Audionet units daisy chained to the Audionet Link output of your ART G3 with a little delay to avoid all units switching on at the same moment, which could cause an overload of your mains fuse. First, control output **Audionet Link OUT 1** 2, then **Audionet Link OUT 2** 3 is activated.



- Independently from the Audionet Link interface, you can switch on/off manually your ART G3 at any time by using the **power** key on the front plate or the remote control.



### Important

- In case the option **Set AutoOff** is set to **shut off in 30 min**, the ART G3 shuts down to stand-by mode automatically, if the disc is stopped or no disc inserted and no key of the front panel or remote control is used for at least 30 minutes. This function works independently from a preamplifier that is connected via Audionet Link, i.e. the ART G3 shuts down automatically even if the preamplifier is still switched on (refer to section '*Set AutoOff*' on page 50).

## 6.2 Inserting and removing discs

Open the cover on top of the ART G3 by pushing it to the back using the handle. Put a disc onto the spindle with its printed side facing up. Fix disc with included stabilizer ('Puck'). Please make sure that the stabilizer gives the disc a centred and level position.

Close the disc drawer. The display reads now **Close** and then **Reading disc. . .** After reading the table of contents the display shows the number of tracks and the total playing time of the disc in minutes and seconds:

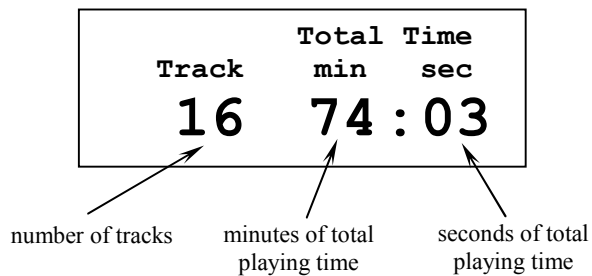

Stop playback by pressing the key **stop** on the front panel or key **■** of the Audionet Metal Remote Control *RC 1*, before you open the cover. Please wait until the disc stops turning, before you remove the stabilizer to remove the disc.

As long as the cover is open the display reads **Open**.



## Note

- If you open the cover during playback the ART G3 takes a short moment to bring the disc to a complete stop. Please wait until the disc stops turning before you remove the disc.
- The cover has to be closed completely in order to playback a disc.
- Always use the included stabilizer to fix the disc on the spindle. Otherwise the disc and/or the unit might suffer damage.
- **Never** load more than one disc at a time, and never use any additional stabilizers!
- Do not use any non-standard shaped discs available on the market because it may damage the unit.
- If you set the option **Set AutoPlay** to **disc change only** or **power on & disc change**, the ART G3 starts playback automatically as soon as you inserted a disc and closed the cover (refer to section '*Set AutoPlay*' on page 50).

## 6.3 Control elements on the front panel

The front panel has 4 keys for controlling the ART G3 (refer to section '*Overview front panel*' on page 7). With these keys you can control all basic playback functions as well as all setup options in the **Global Setup** menu.

<b>power</b>	Switch on /off the unit.
<b>stop / set</b>	Push the key shortly to stop playback. Keep the key pushed for at least 2 seconds to enter and navigate through the <b>Global Setup</b> menu.
<b>back / pause</b>	Push the key shortly to skip back to the beginning of the current track. Push the key again to skip to the start of previous tracks. Keep the key pushed for at least 2 seconds to pause playback. To continue playback press the key for at least 2 seconds again.
<b>skip / play</b>	Press key once to skip to the beginning of the next track. Press again to skip to the start of further tracks.

## 7 Audionet Metal Remote Control

Every function of the ART G3 is accessible via the Audionet Metal Remote Control *RC I*. Additionally, you are able to control power on/off, volume, muting and input channel selection of an Audionet preamplifier.

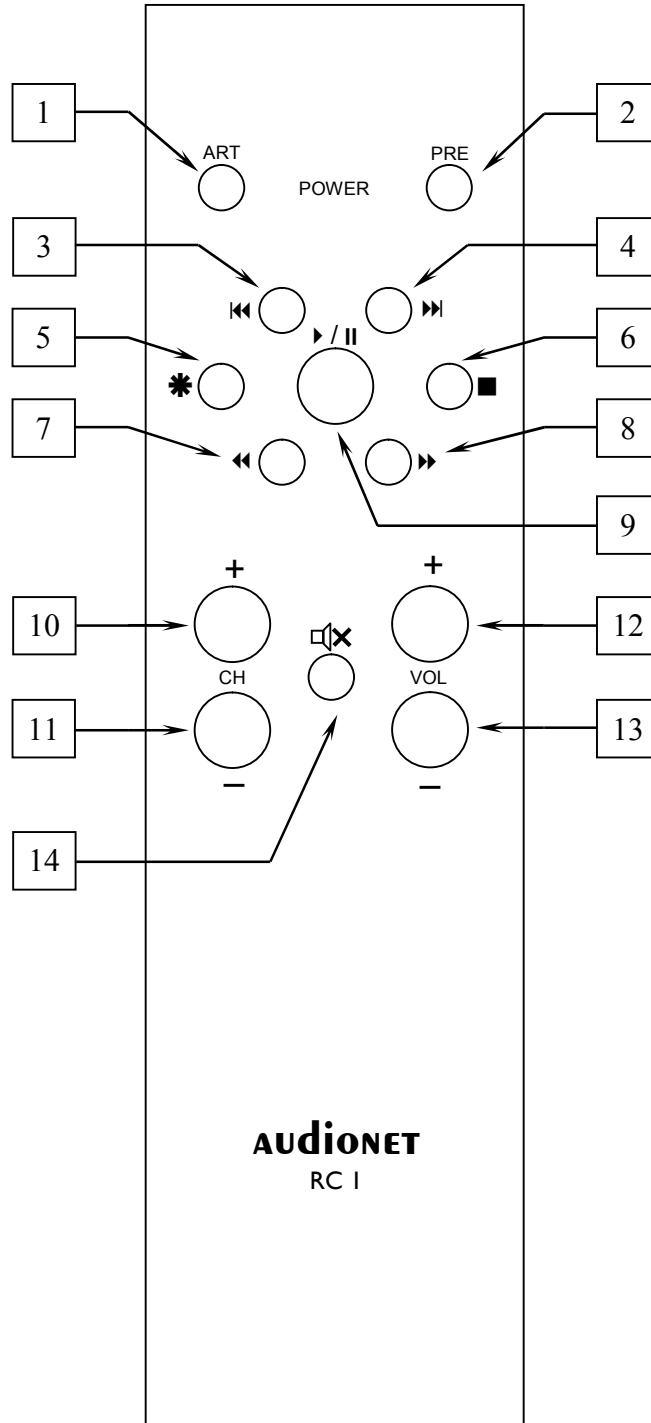

## 7.1 Key Assignment RC 1

No.	Key	Function
1	<b>ART</b>	power on/off ART G3
2	<b>PRE</b>	power on/off Audionet preamplifier
3	⏮	skip to previous track
4	⏭	skip to next track
5	*	enter/navigate Global Setup & Playback Options menu
6	■	stop playback
7	⏪	search backwards
8	⏩	search forwards
9	▶ /	start/resume playback; press long for pause
10	<b>CH +</b>	select next input channel of Audionet preamplifier
11	<b>CH -</b>	select previous input channel of Audionet preamplifier
12	<b>VOL +</b>	increase volume of Audionet preamplifier
13	<b>VOL -</b>	decrease volume of Audionet preamplifier
14	🔇	mute/un-mute Audionet preamplifier

### 1 Power key **ART** for ART G3

Use the power key **ART** to switch on/off the ART G3. This key has the same function as the **power** key on the front panel. If the ART G3 is in stand-by mode, **ART** switches on the unit. If the ART G3 is already switched on, **ART** switches off the unit into stand-by mode.

### 2 Power key **PRE** for Audionet preamplifier

Use the power key **PRE** to switch on/off an Audionet preamplifier. This key has the same function as the **power** key on the front panel. If the Audionet preamplifier is in stand-by mode, **PRE** switches on the unit. If the Audionet preamplifier is already switched on, **PRE** switches off the unit into stand-by mode.

### 3 Skip back key ⏮

skips back to start of current track. Press again to skip to start of previous tracks (see section '*Basic playback control*' on page 34). Also it is used for selecting options in the **Global Setup** menu (see section '*Setup menu Global Setup*' on page 46) and the **Playback Options** menu (see section '*Playback Options menu*' on page 36).

### 4 Skip forward key ⏭

skips to beginning of next track (see section '*Basic playback control*' on page 34). Also it is used for selecting options in the **Global Setup** menu (see section '*Setup menu Global Setup*' on page 46) ) and the

**Playback Options** menu (see section '*Playback Options menu*' on page 36).

- 5 Setup key \***  
enters and navigates through the **Global Setup** and **Playback Options** menu (see section '*Setup menu Global Setup*' on page 46 and '*Playback Options menu*' on page 36). This key works similar to the **set** key on the front panel.
- 6 Stop key ■**  
stops playback (see section '*Basic playback control*' on page 34) and deletes playlists (see section '*Delete a playlist*' on page 45).
- 7 Search backwards key ◀◀**  
searches disc backwards (see section '*Searching*' on page 35). This key is also for editing playlists (see section '*Edit a playlist*' on page 42).
- 8 Search forwards key ▶▶**  
searches disc forwards (see section '*Searching*' on page 35). This key is also for editing playlists (see section '*Edit a playlist*' on page 42).
- 9 Playback/Pause key ▶ / II**  
starts/resumes playback. Press and hold for longer than 2 sec to pause playback at current disc position. Press again to resume playback (see section '*Basic playback control*' on page 34).
- 10 Channel up key CH +**  
selects the next input channel of an Audionet preamplifier.
- 11 Channel down key CH -**  
selects the previous input channel of an Audionet preamplifier.
- 12 Volume up key VOL +**  
increases the volume setting of an Audionet preamplifier.
- 13 Volume down key VOL -**  
decreases the volume setting of an Audionet preamplifier.
- 14 Mute key □/X**  
mutes an Audionet preamplifier. Press again to return to previous volume setting.

## 7.2 Changing the batteries

In order to exchange the batteries of your Audionet Metal Remote Control *RC 1*, first you have to remove the 6 Phillips head screws on the bottom side.



The battery compartment is to the left side of the circuit board. You need 2 batteries type 'AAA' or 'Micro' with a voltage of 1.5V.

Battery compartment



### Important

- While inserting the batteries please mind their orientation. The correct orientation is printed onto the bottom of the battery compartment.

## 7.3 Settings for Audionet preamplifier

The Audionet Metal Remote Control *RC 1* not only able to control the ART G3. It has additional 6 keys to control an Audionet preamplifier. The previous section '*Key Assignment RC 1*' explains the function of these keys.

Depending on their type, Audionet preamplifiers use different system addresses for their remote control code. A DIP switch on the circuit board of the Audionet Metal Remote Control *RC 1* selects the desired system address.

In order to set the system address you first have to open up the remote control (see section '*Changing the batteries*' on page 30). The DIP switch for selecting the system address is located here:

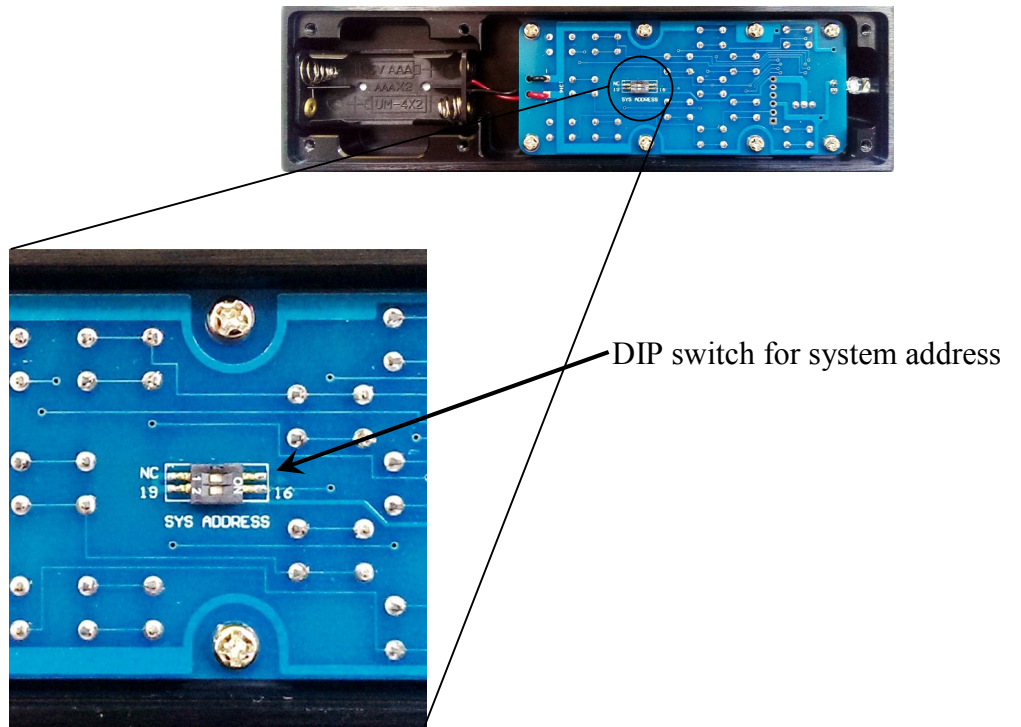

Put the DIP switch labelled 'SYS ADDRESS' in position '19' or '16' according to the following table:

Audionet preamplifier	Address
PRE G2, PRE 1 G3, SAM G2, DNA, DNP, DNA 1	19
MAP 1	16



#### Note

- If not ordered explicitly, the Audionet Metall Remote Control is pre-configured to setting '19' of the DIP switch.
- Older models of Audionet preamplifiers use system address 16.



#### Tip

- If you own an Audionet preamplifier that is not listed in the table above and/or you don't know which system address it uses, then simply try out both settings.

## 8 Playing discs

If the ART G3 is not switched on yet, press the **power** key on the front panel or key **ART** of the Audionet Metal Remote Control *RC 1* to switch on the unit.

Open the cover on top of the unit by pushing it to the back.

Put a disc onto the spindle with its printed side facing up. Fix disc with included stabilizer ('Puck'). Please make sure that the stabilizer gives the disc a centred and level position.



### Important

- **Never** load more than one disc at a time, and never use any additional stabilizers!

Press key **play** on the front panel or **▶** of the Audionet Metal Remote Control *RC 1* to start playback.

### 8.1 Playable disc types

The following disc types are suitable for playback:

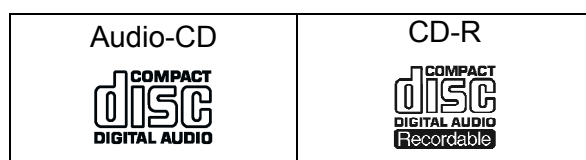

Discs of types CD-R can be played back if they were recorded in the Audio-CD format. Due to characteristics of the disc or recording conditions, in some cases playback might not be possible.



### Important

- Possibly, some Audio CDs not compliant to the Red Book standard will not play correctly or not at all on the ART G3. Particularly copy-protected CDs often violate the standard. Please notice the logos and notes on the CD and/or booklet.
- **If you playback a DTS<sup>\*2</sup> Music CD with the ART G3, all analog outputs will always and the digital outputs, OUT 1 **9**, OUT 2 **10** and OUT 3 **11** will output in HighBit mode a high level noise, that might damage your speakers!**

---

<sup>\*2</sup> DTS and the DTS Digital Surround are registered trademarks of Digital Theater Systems, Inc.



- **Make absolutely sure that you playback DTS Music CDs via a DTS-compatible AV (pre) amplifier only. The AV (pre) amplifier has to be connected to the digital output OUT 4 14 of the ART G3. If you use a different digital output of the ART G3, the option Set Digital Output Mode must be set to LowBit Mode!**
- DTS Music CDs are usually marked:



#### Note

- The ART G3 can playback audio recorded on CD-G, CD-EXTRA and CD-TEXT discs.



#### Tip

- Connect your ART G3 to an Audionet (pre) amplifier with Audionet HighBit Interface using digital output **OUT 1 & OUT 2**. Make a second connection from digital output **OUT 4** of the ART G3 to the optical digital input of the Audionet (pre) amplifier. The advantage of this setup is that you can leave the digital output format of the ART G3 set to HighBit mode. Listen to normal audio CDs in HighBit mode with all your preferred settings for 2-channel playback. In case you want to listen to a DTS Music CD, you simply switch your Audionet (pre) amplifier to its optical digital input. All your preferred settings for multi-channel playback will be recalled automatically so you can enjoy listening to your DTS Music CD without any interference.

## 8.2 Basic playback control

The table below comprises the basic playback functions into a simple overview. The advanced functions are explained in detail in the following sections.

Key	Function
<b>skip/play</b> or ▶ /    (short)	Start / resume playback.
<b>back/pause</b> (long) or ▶ /    (long)	Pause playback.
<b>stop/set</b> (short) or ■	Stop playback.
⏮	Search backwards. Press <b>skip/play</b> or ▶ /    (short) to return to normal playback.
⏭	Search forward. Press <b>skip/play</b> or ▶ /    (short) to return to normal playback.
<b>back/pause</b> (short) or ⏮	Skips to beginning of current track. Press again to skip to start of previous tracks.
<b>skip/play</b> or ⏭	Skip to beginning of next track.

### 8.3 Searching

You can search discs forward and backwards with several speeds.

1. During playback press ◀◀ or ▶▶ to start the search mode.
2. Press the key again to increase search speed.
3. Press key **play** or ▶ / || to continue normal playback.

Both search direction and search speed are shown in the display:

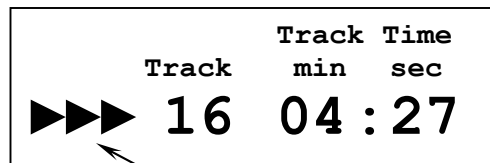

Search direction and search speed:

- ▶▶ forwards, slow speed
- ▶▶▶ forwards, medium speed
- ▶▶▶▶ forwards, high speed
- ◀◀ backwards, slow speed
- ◀◀◀ backwards, medium speed
- ◀◀◀◀ backwards, high speed



#### Note

- To start searching the disc has to be in playback or pause mode.
- Search mode is suspended as soon as any other playback or menu function is selected.
- While searching in one direction, the search speed is reduced one step, each time the search key for the opposite direction is selected until the normal playback speed is reached.

## 9 Playback Options menu

The **Playback Options** menu offers advanced functions during playback. Use setup key **\*** on the Audionet Metal Remote Control *RC 1* to skip through the items of the **Playback Options** menu. Use keys **◀** and **▶** to select your desired setting.

Order of items in the **Playback Options** menu:

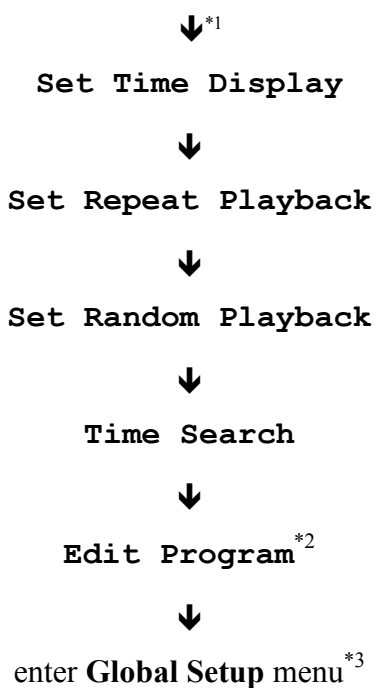

### Note

- To leave the menu press and hold setup key **\*** for longer than 2 sec.
- After 12 sec the ART G3 will leave the menu automatically and return to the main display mask.
- During adjustments of the display brightness is set to 100% for better readability. After leaving the menu the user selected brightness level will be restored.



### Tip

- To enter the **Global Setup** menu directly press and hold setup key **\*** for longer than 2 sec. Navigate to next menu item by short keystrokes on **\***.

---

<sup>\*1</sup> ↓ = press setup key **\*** for less than 2 sec

<sup>\*2</sup> see section '*Program Playback*' and following for different menu item appearance depending on program playback

<sup>\*3</sup> see section '*Setup menu Global Setup*' on page 48

## 9.1 Time Display

During playback of a disc 4 different time display modes are available. Press the key \* of the Audionet Metal Remote Control *RC 1* once to get to the **Playback Options** menu. The first item is **Set Time Display**. Use keys ◀ and ▶ to select desired display mode.

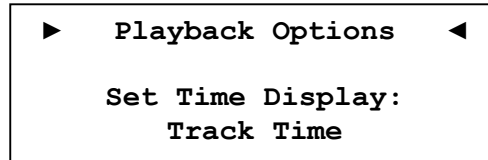

There are 4 time display modes available:

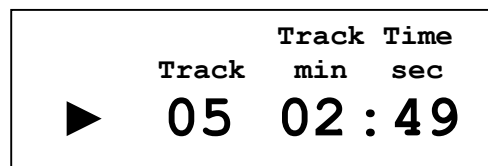

**Track Time** shows the time the current track is playing.

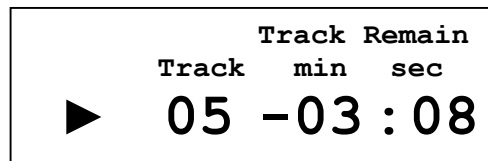

**Track Remain** is the remaining playback time of the current track.

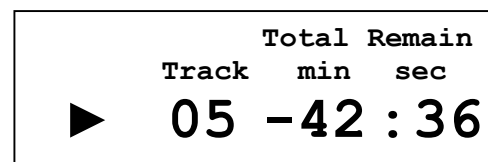

**Total Remain** shows the total remaining playback time of the current disc.



### Note

- During playback of a playlist the total remaining time of the playlist **Prog. Remain** is shown instead of the total remaining playback time of the disc **Total Remain**.

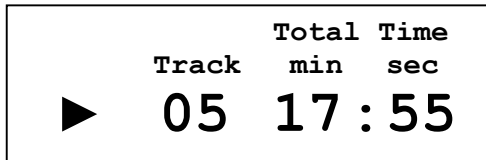

**Total Time** is the total playback time of the current disc.



#### Note

- During playback of a playlist the total playback time of the playlist **Prog. Time** is displayed instead of the total playback time **Total Time** of the current disc.



#### Tip

- To leave the menu press and hold setup key \* for longer than 2 sec.

## 9.2 Repeat Playback

If you would like to repeat the currently inserted disc or just a single track, press the setup key \* on the Audionet Metal Remote Control RC 1 twice to get to the Playback Option **Repeat Playback**.

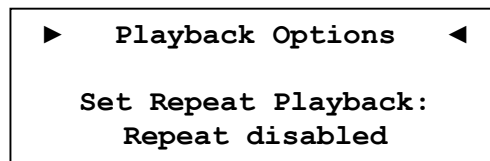

Use keys ◀ and ▶ to select the desired **Repeat Playback** function. Select **Repeat disabled** to switch off the Repeat Playback function.

### 9.2.1 Repeat disc

If you would like to repeat the currently inserted disc, select **Repeat Disc**. The display indicates the disc repeat mode with symbol ↻ **all**.

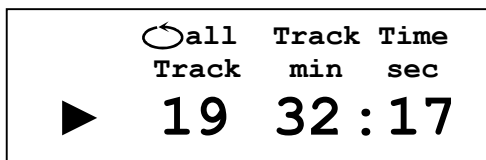

As soon as the end of the disc is reached, playback resumes at the start of the disc. The disc will be repeated until you switch off the disc repeat function or stop playback.

To deactivate the disc repeat function select option **Repeat disabled**. The repeat symbol ↻ **all** is now removed from the display.



### Note

- If you compiled a playlist, not the whole disc but only the tracks of the playlist are repeated.
- You may switch on/off the repeat function before and during playback.
- In case you activated the disc repeat and the random play function, all tracks are played back in random order until every track was played once. Then the playback re-starts with a randomly chosen track.

## 9.2.2 Repeat track

If you would like to repeat only one track of a disc, select option **Repeat Track**. The track repeat mode is indicated by the symbol  **one** in the display.

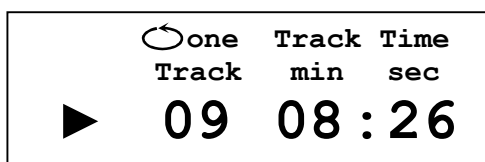

The current track will be looped until you switch off the track repeat function or stop playback.

To deactivate the track repeat function select option **Repeat disabled**. The track repeat symbol  **one** is now removed from the display.



### Note

- You may switch on/off the repeat function before and during playback.
- In case you activated the track repeat and the random play function, only the current track will be repeated nonetheless.

## 9.3 Random playback

Use this function to playback the tracks of a disc or playlist in a randomly order.

Press the setup key **\*** on the Audionet Metal Remote Control *RC 1 3* times to get to the Playback Option **Random Playback**.

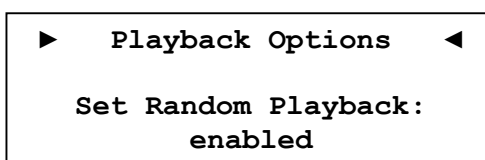

Use keys **⏪** and **⏩** to enabled or disable the **Random Playback** function. If **Random Playback** is enabled, the display will show an active random playback mode by the symbol **Random**:

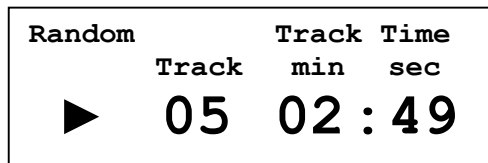

The symbol **Random** will be removed from the display if **Random Playback** is disabled.



#### Note

- If you compiled a playlist, only the tracks of the playlist will be played back in a random order.



#### Tip

- To leave the menu press and hold setup key **\*** for longer than 2 sec.

## 9.4 Time search

You can directly access any time on the disc. Press the setup key **\*** on the Audionet Metal Remote Control *RC I* 4 times to open the **Time Search** dialog in the display of the ART G3. Now enter the time in minutes and seconds you want to go to. Use keys **⏪** and **⏩** to select the right most digit of the desired time. Press key **⏪** to shift all 4 digits one step to the left. Proceed this way until desired time in minutes and seconds is in the display. Press key **▶/||** to start or continue playback at the entered time.

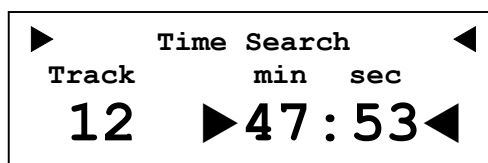

The display shows the entered time and the track number corresponding to that time.

#### Example:

You would like to playback at time 47 minutes and 53 seconds. First, press setup key **\*** 4 times to enter the Time Search dialog. Now use **⏩** to enter a '4' as the right most digit. Press **⏪** to shift digits one step to the left. Press **⏪** repeatedly until the right most digit is '7' and shift with **⏪**. Press **⏪** repeatedly until the right most digit is '5' and shift with **⏪**. For the final digit press **⏩** 3 times. Now you have entered the desired time of



47 minutes and 53 seconds completely. Acknowledge your entry by pressing key ► / || . Playback starts / continues at 47 minutes and 53 seconds.



#### Note

- If you enter a time that is not on the disc the number of the corresponding track is **00** in the display. If you press now ► / || to start / continue playback the ART G3 issues the warning  
► **Time out of range!** ◀  
to let you know that the entered time is not available on the disc.
- Correct a wrong time entry by simply typing in the correct time. The current selected digit is always the 1<sup>st</sup> digit. The other digits are shifted one digit to the left when you press ◀◀. The 1<sup>st</sup> digit will then always reset to '0'.

## 9.5 Program Playback

Use this function to compile a playlist. Tracks will be played back in the order they were programmed into the playlist.

Make sure the disc is stopped. Press the setup key \* on the Audionet Metal Remote Control *RC 1* 5 times to get to the Playback Option **Program Playback** for compiling a playlist. While in the program mode the display offers the following information:

►	<b>Edit Program</b>	◀
	<b>Track 02 → 19 of 19</b>	
	<b>Prog. Time: 47 min 13 sec</b>	
	<b>Add Track: 07</b>	

The 1<sup>st</sup> line of the display indicates that the ART G3 is now in mode for editing programs/playlists.

The 2<sup>nd</sup> line shows the number of current program step and the total number of program steps of the playlist. Additionally, the number of the track currently occupying the current program step is indicated. In the example above the playlist consists of 19 program steps at all, and step 19 is occupied by track no. 2.

The 3<sup>rd</sup> line informs you about the total playing time of the playlist. In the example above the total playing time is 47 minutes and 13 seconds.

The 4<sup>th</sup> line shows the number of the track currently selected to be added to the next program step of the playlist. In this example it is track no. 7.

To add a track to the playlist at first you select the desired track with the keys ◀◀ and ▶▶ of the Audionet Metal Remote Control *RC 1*. Check your current selection by looking at line 4 of the display. Press ▶▶ to insert the currently selected track into the playlist at the current step.

Line 2 of the display proves now that the track was added successfully to the playlist: The total number of program steps was increased by one.

Now add all other tracks you like to the playlist as described above. The playback order corresponds to the programming order.



#### Note

- If you compiled a playlist and the program playback mode is active while the disc is stopped, the total program (playlist) playing time **Prog. Time** is indicated in the display instead of the total disc playing time **Total Time**.
- Of course, you can program one track several times to different program steps. The playlist is only limited to a maximum of 99 program steps or a maximum playing time of 99 minutes and 59 seconds. If the maximum number of program steps or the maximum program playing time exceeds during programming the ART G3 will issue the warning

**Program full!**

to let you know that you cannot add the currently selected track.

- Please refer to section '*Edit a playlist*' on page 42 for how to erase single tracks from the playlist or how to insert single tracks into an existing playlist.

### 9.5.1 Edit a playlist

Provided that you already entered a playlist, you can still edit the list to your likes. Make sure the disc is stopped, then press the setup key **\*** on the Audionet Metal Remote Control *RC 1* 5 times to get to the **Program Play Options**.

```
▶ Program Play Options ◀  
  
edit      -> press ◀◀  
disable   -> press ■
```

Now press ◀◀ to get to the program/playlist edit mode. The display shows the same dialog as for adding tracks to the playlist (refer to section '*Program Playback*' on page 41):

```
▶ Edit Program ◀  
Track 02 → 05 of 16  
Prog. Time: 47 min 13 sec  
Add Track: 07
```

By pressing key ◀◀ repeatedly you can skip through the program steps of the playlist and check the corresponding track numbers. Refer to display line 2 in the **Edit Program** dialog. In the example above the playlist consists of 16 program steps, step no. 5 is occupied by track 2.

As explained in section 'Program Playback' on page Program Playback, you can select tracks to add to the playlist by using keys ◀◀ and ▶▶ of the Audionet Metal Remote Control RC 1. The currently selected track is indicated in display line 3. In the example above it is track 7.

To add the selected track to the playlist press key ▶▶ of the Audionet Metal Remote Control RC 1. The selected track will be added to the playlist after the currently displayed program step. All further program steps will be pushed one step ahead. In the example above track no. 7 will be inserted after program step 5 (in this case track no. 2). The playlist will then consist of 17 program steps. The total playing time of the playlist is indicated by line 3 of the display

If you would like to erase a track from the playlist press key ◀◀ of the Audionet Metal Remote Control RC 1 repeatedly until the track to be erased is indicated by line 2 of the display.

Erase now the selected program step by pressing key ■. The corresponding track is now deleted from the playlist. All following program steps will be shifted one step back. The total number of program steps and the total playing time of the playlist is updated.

**Example:**

Your playlist consists of the following tracks in the order:

<b>Program step</b>	1	2	3	4	
<b>Track no.</b>	07	12	18	03	

You would like to insert track no. 9 between tracks no. 12 and no. 18 (respectively program steps 2 and 3).

Repeat pressing ◀◀ until line 2 of the display reads:

**Track 12 → 02 of 04**

Now press ▶▶ repeatedly until line 4 of the display reads:

**Add Track: 09**

Insert track no. 9 into the playlist by pressing key ▶▶. The playback order is now:

<b>Program step</b>	1	2	3	4	5
<b>Track no.</b>	07	12	09	18	03

Now you would like to erase track no. 18 from the playlist.

Repeat pressing ◀ until line 2 of the display reads:

**Track 18 → 04 of 05**

Erase track no. 18 (respectively program step 4) from the playlist by pressing ■. The new playback order is:

Program step	1	2	3	4	
Track no.	07	12	09	03	



### Important

- This function is only available if you use the Audionet Metal Remote Control *RC I*!

## 9.5.2 Playing a playlist

As soon as you finished compiling a playlist you can start playback by pressing key ▶/|| of the Audionet Metal Remote Control *RC I* or key **skip / play** on the front panel. Playback starts now with the first track programmed into the playlist.

The display indicates playlist playback by the symbol **Prog:** in the upper left corner. Directly below you will find the number of the current program step and the total number of program steps of the playlist:

<b>Prog:</b>		<b>Track</b>	<b>Time</b>
02/17		min	sec
▶	<b>19</b>	<b>32</b>	<b>:17</b>

In the example above track no. 19 is playing. This is step 2 of 17 in the playlist.



### Note

- If the random play function is active symbol **Prog:** is replaced by symbol **Random** in the display. Nevertheless, the number of the current program step playing and the total number of program steps in the playlist is still indicated.
- If you stop playback the playlist still resides in the memory. If you start playback again, the playlist will be played again.
- To delete a playlist, please refer to section '*Delete a playlist*' on page 45.
- If you would like to stop playing a playlist during playback and resume normal playback press setup key \* of the Audionet Metal Remote Control *RC I* 5 times to get to the **Program Play Options**.

Now press key **■** to disable **Program Playback**. Playback continues from current track to the end of the disc in normal playback mode. If you like to start playback of the playlist still in memory again stop playback first (press **■**). Then press setup key **\* 5** times to get to the **Program Play Options**. Enable program playback by pressing key **▶**. Playback starts right after pressing key **▶** or **skip / play**.

### 9.5.3 Delete a playlist

In order to delete a playlist from the memory press key **stop / set** on the front panel or **■** on the Audionet Metal Remote Control *RC 1* while playback is already stopped. The following dialog will be displayed:

▶	<b>Delete Program?</b>	◀
<b>Yes</b>	<b>-&gt; Press STOP</b>	
<b>No</b>	<b>-&gt; Press any other key</b>	

Press key **stop / set** or **■** again to delete the playlist.

If you decide not to erase the playlist press any other key or simply wait approx. 12 seconds for the ART G3 returning to normal display mode.

## 10 Setup menu Global Setup

If you hold key **stop / set** on the front panel for longer than 2 seconds, you enter the **Global Setup** menu of the ART G3. Press and hold key **stop / set** for longer than 2 seconds again to advance to the next menu item. After the last option you leave the menu. To adjust an option use keys **back / pause** and **skip / play**.

Order of options in the **Global Setup** menu:

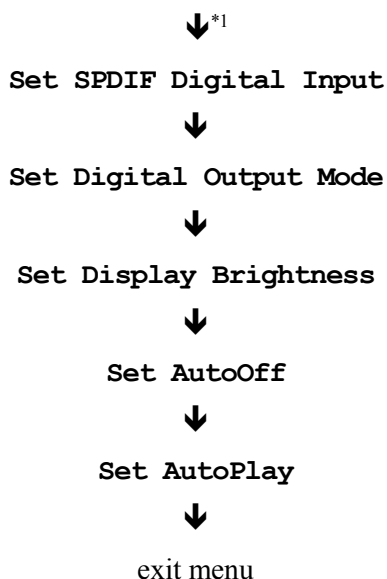

### Tip

- All options of the **Global Setup** menu can be adjusted using the keys of the front panel, but much more comfortable is the Audionet Metal Remote Control *RC 1*.
- To enter the Global Setup menu directly press and hold setup key **\*** for longer than 2 sec. Navigate to next menu item by short keystrokes on **\***.
- To select an option use keys **◀** and **▶** of the Audionet Metal Remote Control *RC 1*. In the **Global Setup** menu the key **back / pause** on the front panel has the same function as key **◀** of the Audionet Metal Remote Control *RC 1*. Also, keys **skip / play** and **▶** have the same function.



### Note

- You can enter the **Global Setup** menu at any time by holding key **stop / set** or **\*** for longer than 2 seconds, even during playback.

---

\*1 ↓ = press and hold key **stop / set** for longer than 2 sec.

- If you adjust an option of the **Global Setup** menu during playback, pressing key **stop / set** shortly (less than 2 seconds) will still stop playback (refer to section '*Playing discs*' on page 32).
- If you make no adjustments for longer than 12 seconds the ART G3 will leave the **Global Setup** menu automatically.
- During adjustments of the display brightness is set to 100% for better readability. After leaving the menu the user selected brightness level will be restored.
- If you switch off the unit to stand-by mode all adjustments will be stored in the non-volatile memory of the ART G3. Even after disconnecting from the mains your ART G3 will still remember your settings.

In the following the options of the **Global Setup** menu are explained in detail.

## 10.1 Set SPDIF Digital Input

To select the active digital input of the ART G3, press the **stop / set**-key once for at least 2 seconds. Use keys **back / pause** and **skip / play** to select the preferred digital input.

**IN 1 (electrical) or USB** Use this option to activate the **Digital Audio IN 1** 15 of the ART G3.

**IN 2 (optical)** Use this option to activate the optical input **Digital Audio IN 1** 16.



### Tip

- On the Audionet Metal Remote Control *RC 1* use setup key **\*** get to menu item **Set SPDIF Digital Input**. Use keys **◀** and **▶** to select the preferred digital input.

## 10.2 Set Digital Output Mode

To adjust the output format of the digital outputs of the ART G3 press key **stop / set** long twice. Use keys **back / pause** and **skip / play** to select the output format.

**LowBit Mode** Use the LowBit mode if the ART G3 is connected to a unit that **does not support** the Audionet HighBit Interface.

**HighBit Mode** Use the HighBit mode **only** if you connect the ART G3 to a unit that **supports** the Audionet HighBit Interface, like Audionet DNx (except DNA 1) or Audionet MAP 1.

**disabled** All digital outputs are disabled. Select this option if you do not use any of the digital outputs of the ART G3.



### Important

- If you do not need any of the digital outputs do not use any jumpers to short-circuit the digital outputs. Instead, select **disabled** for option **Set Digital Output Mode** to switch off all digital outputs.

Please refer to the following tables to determine which digital output format at which sample rate and resolution is available at the digital audio outputs. The decision whether to use the HighBit or the LowBit mode depends on the kind of digital receiver unit your ART G3 is connected to (refer to section 'Digital output format' on page 14).

Digital Output Mode	OUT 1 <span style="border: 1px solid black; padding: 0 2px;">9</span> SPDIF	OUT 2 <span style="border: 1px solid black; padding: 0 2px;">10</span> SPDIF	OUT 3 <span style="border: 1px solid black; padding: 0 2px;">11</span> AES/EBU	OUT 4 <span style="border: 1px solid black; padding: 0 2px;">14</span> optical
<b>LowBit Mode</b>	44.1kHz / 16bit Stereo PCM	44.1kHz / 16bit Stereo PCM	44.1kHz / 16bit Stereo PCM	44.1kHz / 16bit Stereo PCM
<b>HighBit Mode</b>	192kHz / 24bit Stereo Upsampling Audionet High Bit Mode		96kHz / 24bit Stereo Downsampling PCM	44.1kHz / 16bit Stereo PCM
<b>disabled</b>	no signal	no signal	no signal	no signal



### Tip

- On the Audionet Metal Remote Control *RC I* use setup key **\*** to get to menu item **Set Digital Output Mode**. Use keys **◀** and **▶** to select the digital output format.



### 10.3 Set Display Brightness

To adjust the brightness of the display of the ART G3 press key **stop / set** long 3 times. Use keys **back / pause** and **skip / play** to adjust the brightness.



#### Important

- **Long-term usage of the display set to maximum brightness (setting 100%) may cause extended signs of wear resulting in a decay of contrast or brightness of individual dots in the display. Do not use the display with a brightness set higher than the factory default setting of 50% over a longer period of time.**



#### Note

- Is the brightness set to **Off** the display is only on during setup adjustments and will switch off several seconds after the last entry. The same applies for direct track access, time search and skipping/searching.
- If the disc is stopped, the cover opened or no disc inserted while the cover is closed, the ART G3 automatically activates the display saver after 10 minutes without user entry.
- During active display saver, all messages will be displayed at 25% brightness and varying locations in the display changing every 12 seconds to prevent any 'burn-in' effects of the display.
- During active display saver, the total playing time is displayed in the form **16Tracks 74min 03sec** while the disc is stopped.



#### Tip

- On the Audionet Metal Remote Control *RC 1* use setup key **\*** to get to menu item **Set Display Brightness**. Use keys **◀** and **▶** to adjust the brightness of the display.

## 10.4 Set AutoOff

To adjust the automatic shut-off feature of the ART G3 press key **stop / set** long for 4 times. Use keys **back / pause** and **skip / play** to select the preferred function.

**never auto shut off** The automatic shut-off feature is deactivated. The ART G3 stays switched on until it is switched off by the **power** key on the front panel, the remote control or the Audionet Link.

**auto shut off in 30 min** The automatic shut-off feature is active. In case the ART G3 is stopped or the cover is left open for longer than 30 minutes without receiving any command from the keys on the front panel, the remote control or the Audionet Link, the unit will shut off to stand-by mode automatically.



### Tip

- On the Audionet Metal Remote Control *RC 1* use setup key **\*** to get to menu item **Set AutoOff**. Press keys **◀** and **▶** to activate or deactivate the automatic shut-off feature.

## 10.5 Set AutoPlay

To adjust the automatic playback feature of the ART G3 press key **stop / set** long for 5 times. Use keys **back / pause** and **skip / play** to select the preferred function.

**never** The ART G3 never starts playback automatically.

**power on only** Playback starts automatically only if the unit is connected to mains while a disc is inserted and the cover closed. Use this function if you like to control the ART G3 by a timer.

**disc change only** As soon as a disc is inserted and the cover closed playback starts automatically after reading the table of contents of the disc.

**power on & disc change** Combination of settings **power on only** and **Disc change only**.



### Tip

- On the Audionet Metal Remote Control *RC 1* use setup key \* to get to menu item **Set AutoPlay**. Press keys ◀ and ▶ to select the preferred setting.

## 10.6 Overview factory defaults

Option	Setting
Set SPDIF Digital Input	IN2 (optical)
Set Digital Out Mode	disabled
Set Display Brightness	50%
Set AutoOff	never auto shut off
Set AutoPlay	never

## 11 Security advice



### Important

- Avoid packaging material, especially plastic bags, coming into children's hands!
- Store and operate the unit in a dry room at a reasonable room temperature only!
- Avoid moisture, any liquids, dirt or small objects getting into the unit!
- Set up the unit in a sufficiently ventilated environment!
- Do not cover the unit!
- Do not open the unit. Unauthorised opening will void warranty!
- Do not short-circuit the outputs!
- During connecting or removing the ART G3 to/from a preamplifier both units and the corresponding power amplifiers have to be switched off to prevent damage of the ART G3 or any of the other connected units.
- Use dry cloth for cleaning!

We would like to wish you many exciting listening experiences with your new Audionet product.

If you still have any questions, do not hesitate to ask your competent Audionet dealer or contact us directly.

## 12 Technical data

<b>Function</b>	Compact Disc Player
<b>Laser system</b>	Semiconductor laser, 780 nm wave length
<b>Converter</b>	192 kHz / 24 Bit, Dual Mono DAC, Multibit-Delta-Sigma method
<b>Sample rate</b>	44.1 kHz
<b>Audio bandwidth</b>	0 – 90000 Hz (-3 dB) analog
<b>THD+N</b>	typ. >100 dB (A weighted) @ -60 dBFS
<b>SNR</b>	> 110 dB
<b>Channel separation</b>	> 130 dB @ 10 kHz
<b>Outputs</b>	1 pair of RCA analog, gold plated, teflon insulated 1 pair of XLR analog, gold plated 2 RCA digital, gold plated, 600 mV <sub>ss</sub> in 75 Ohm 1 AES/EBU digital, 110 Ohm, gold plated 1 SPDIF optical digital 2 Audionet Link, optical (All digital outputs can be de-activated!)
<b>Inputs</b>	1 USB, as USB-Audio (44,1 kHz/16 bit, 48 kHz/16 bit) or SPDIF (32 kHz-96 kHz/24 bit) 1 SPDIF optical TosLink, (32 kHz-96 kHz/24 bit) 1 Audionet Link, optical
<b>Output impedance analog</b>	33 Ohm real
<b>Output level analog</b>	3.5 V <sub>RMS</sub>
<b>Mains</b>	220..240 V or 110..120 V, 50...60 Hz
<b>Power consumption</b>	< 1 W Stand by, max. 40 W
<b>Dimensions</b>	Width 430 mm Height 120 mm Depth 360 mm
<b>Weight</b>	22 kg

<b>Finish</b>	<p><b>Front:</b> brushed aluminium, 10 mm, black anodised, white print or aluminium 'nature', 10 mm, anodised, black print</p> <p><b>Display:</b> red or blue</p> <p><b>Top:</b> MDF, Nextel coated</p> <p><b>Cover:</b> aluminium, black anodised</p> <p><b>Chassis:</b> granite, steel, black</p>
<b>Features</b>	<ul style="list-style-type: none"> <li>- Audionet Metal Remote Control <i>RC 1</i> (included)</li> <li>- D/A converter with USB/SPDIF digital input</li> <li>- Top loader, absorbing MDF, aluminium and granite casing</li> <li>- massive disc drawer cover made of 10 mm aluminium, Teflon-bedded</li> <li>- decoupling of the transport unit by Audionet Aligned Resonance technology</li> <li>- special stabilizer made of POM</li> <li>- separate power supplies for digital and analog sections</li> <li>- Audionet Intelligent Sampling technology</li> <li>- discrete, extremely fast and stable filter and output stages</li> <li>- fully DC coupled, no capacitors in the signal path</li> <li>- Audionet HighBit interface</li> <li>- disengageable digital outputs</li> <li>- capable of de-emphasis processing</li> <li>- optional external power supply Audionet EPS or Audionet EPX for the analog section</li> </ul>

Errors and omissions excepted. Specifications and design are subject to changes without prior notice.

# AUDIONET

audionet GmbH

Brunsbütteler Damm 140 B

13581 Berlin, Germany

[www.audionet.de](http://www.audionet.de)

[kontakt@audionet.de](mailto:kontakt@audionet.de)

Errors and omissions excepted. Specifications and design are subject to changes without prior notice.